



Microwave Motion Sensor

Product Specifications



EUFOMS1 is an innovative motion detector that uses 5.8GHz high frequency that can detect motion through plastic, glass and thin non-metal materials.

The sensor supplies a simple energy-saving solution to use light only when and where you need it. It automatically switches on/off light based on motion and ambient light level. The EUFOMS1 can control a variety of luminaires such as halogen, fluorescent and LED.

Reasons to choose the EUFOMS1 Motion Sensor from TCP

- Automatic switching based on motion and light level
- Zero-crossing point operation helps protect the sensor against in-rush current
- 5.8GHz microwave module provides detection for mounting heights up to 15m
- Easy installation with TCP's EUFO high bay
- Detection area, time delay and daylight threshold can be precisely set via remote control
*remote sold separately
- Wide detection area, range up to 16m in diameter

Ideal Applications

- Warehouses
- Storage
- Manufacturing Facilities

Specifications

Operating voltage	12-24V DC
HF system	5.8GHz ± 7.5MHz, ISM wave band
Transmitting power	<0.2mW
Power consumption	≤0.5W (standby)
Detection zone	Max.(D x H): 16m x 12m
Detection sensitivity	20% / 50% / 75% / 100%
Hold time	5s / 30s / 90s / 3min / 20min / 30min
Daylight sensor	2 Lux / 5 Lux / 10 Lux / 25 Lux / 50 Lux / 100 Lux / Disable
Mounting height	12m Max.
Motion detection	0.5-3m/s
Detection angle	150°(wall installation) 360°(ceiling installation)
Operating temperature	-20°C to 60°C
IP rating	IP20

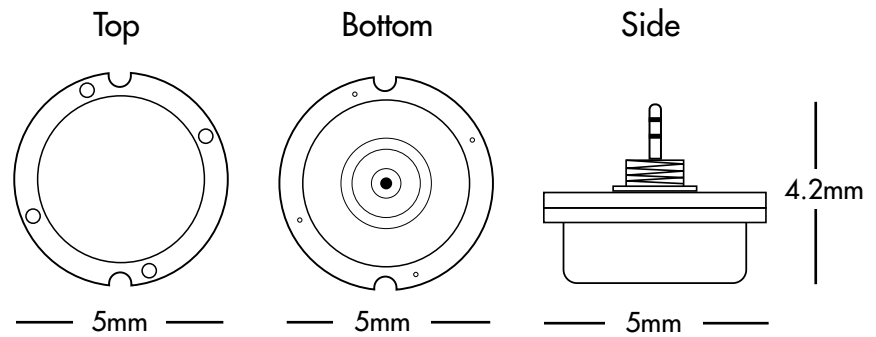

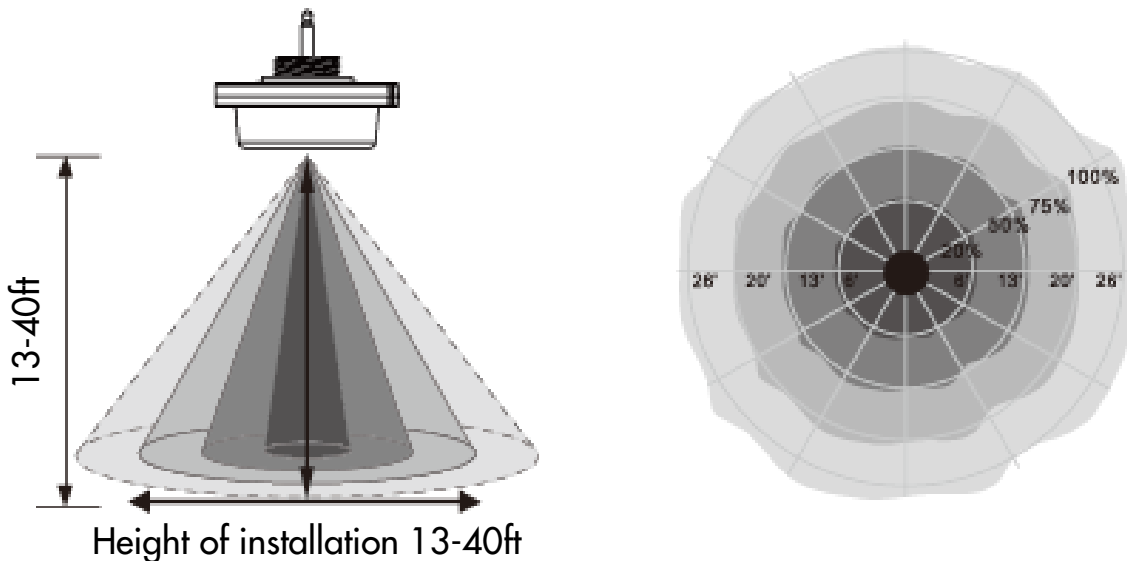

Detection Pattern













Remote Instructions



LED	DESCRIPTION	LED	DESCRIPTION
BRIGHTNESS	Set the brightness level when occupancy is sensed and luminaire is switched on.		Set the current lux value as the daylight threshold. This feature enables the daylight sensor to function in all applications. *In applicable sensors only
SENSITIVITY	To set the occupancy sensing sensitivity of the sensor.		The daylight sensor is turned off and the sensor functions in standard or bi-level dimming mode.
HOLD TIME	The time the sensor remains at full brightness before turning off or entering standby mode.	STANDBY DIM	To set the bi-level dimming after the initial hold time. Setting standby dim level at 0% means the device will turn off after the initial hold time (Standard mode). Setting standby dim level to the other provided options will place the device in bi-level mode.
DAYLIGHT SENSOR	Preset threshold levels for the daylight sensing functions. *In applicable sensors only	STANDBY TIME	Represents the time that the sensor will keep the light at low dim level after the HOLD TIME has elapsed.

Button Operation

BUTTON	DESCRIPTION	BUTTON	DESCRIPTION
	Press the ON/OFF button, the light goes to permanent on or permanent off mode, and the sensor is disabled (Must press the AUTO button to quit this mode for setting).		Press AUTO button, the sensor starts to function and all settings remain the same as the latest status before the light is switched on/off.
	Display the current/latest setting parameters in LED indicators (the LED indicators will turn on for showing the setting parameters).		The button TEST 2s is for testing purpose sensitivity only after you choose sensitivity thresholds, then you press the TEST 2s button. The sensor goes to test mode (hold time is only 2s) automatically, meanwhile the standby period and daylight sensor are disabled. Press AUTO button to quit from this mode.
	Press RESET button, all settings go back the settings of the dip switch in sensor.		
	Select active parameter to edit after selecting DISP. The active function will flash when selected.		Navigate to LEFT and RIGHT to choose between options of the selected parameters in LED indicators.
	Select OK to save the selected settings to the remote. *Settings will be saved to the remote but will still need sent to the device		Open and close smart daylight sensor. Press UP or DOWN, enter in the setting condition, the parameter LEDs of remote control will flash to be selected, press this button to open or close smart daylight sensor. *In applicable sensors only
	Press the SEND button to upload the current settings to the fixture (Press DISP to see current settings.) The fixture will flash on/off to confirm the settings have been received.		
	4 scene modes with preset parameters which are available to be changed and saved in modes.		

TECHNOLOGY CAST IN A BEAUTIFUL LIGHT

For over 30 years, TCP has been designing, developing and delivering energy-efficient lighting into the market. Thanks to our cutting-edge technology and manufacturing expertise, we have shipped billions of high quality lighting products. With TCP, you can count on a lighting product that is designed to meet the needs of the market - that transforms your surroundings and envelopes you in warmth - lighting that generates beauty with every flip of the switch.

Sales:

Date:

Model:

Project:

Rep:

Catalog Number:

Type:

Notes:



For more information on the quality and care TCP can deliver, call us at **800.324.1496** or visit tcp.com

325 Campus Dr. | Aurora, Ohio 44202 | P: 800.324.1496 | F: 877.487.0516